

Дюбел с опорен пръстен, к-кт с винт/PZ SX ф 6 x 30 мм, GKS K NV, блистер

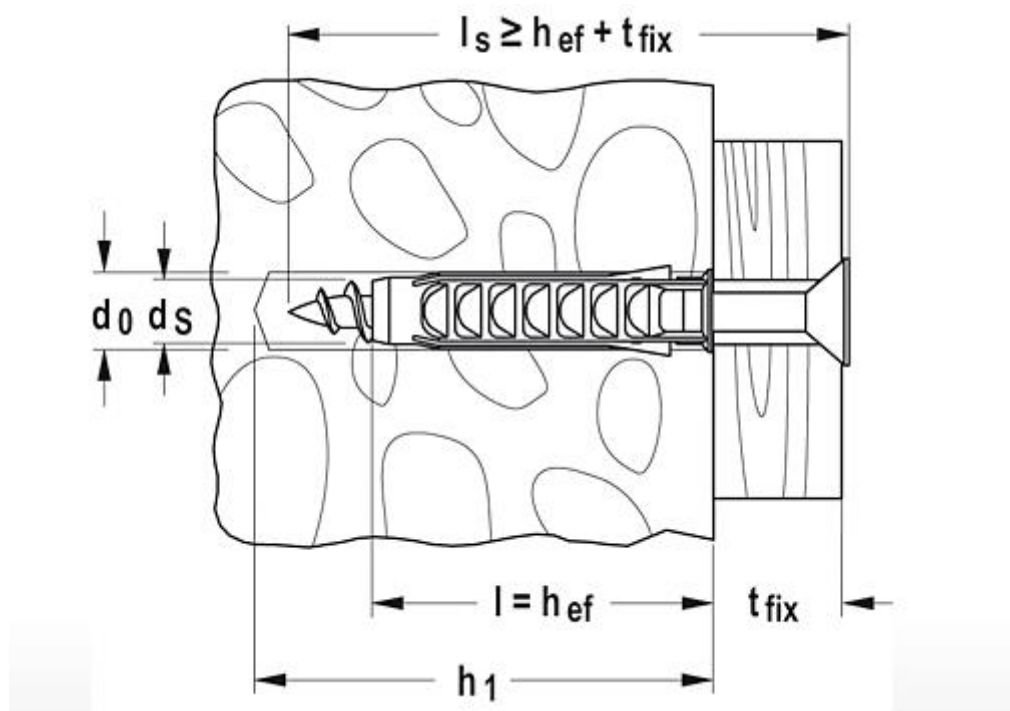

Drill hole diameter	d_0	6	[mm]
Min. drill hole depth	h_1	40	[mm]
Anchor length	l	30	[mm]
Screw	$d_s \times l_s$	4,5 x 45	[mm]
Effect. anchorage depth	h_{ef}	30	[mm]
Drive		PZ2	
Card contents		15 x SX 6 x 30, 15 x wood screw 4.5 x 40	
Sales unit		10	[pcs]
GTIN (EAN Code)		4006209908990	